

7

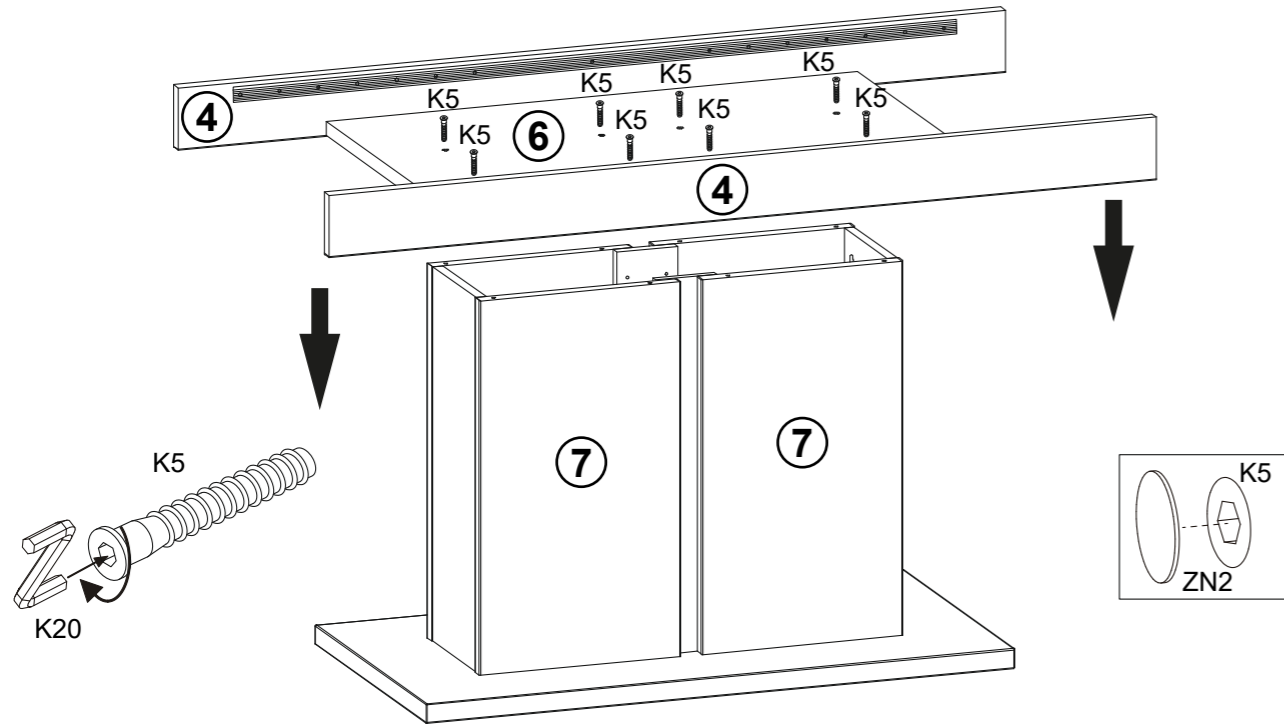

8

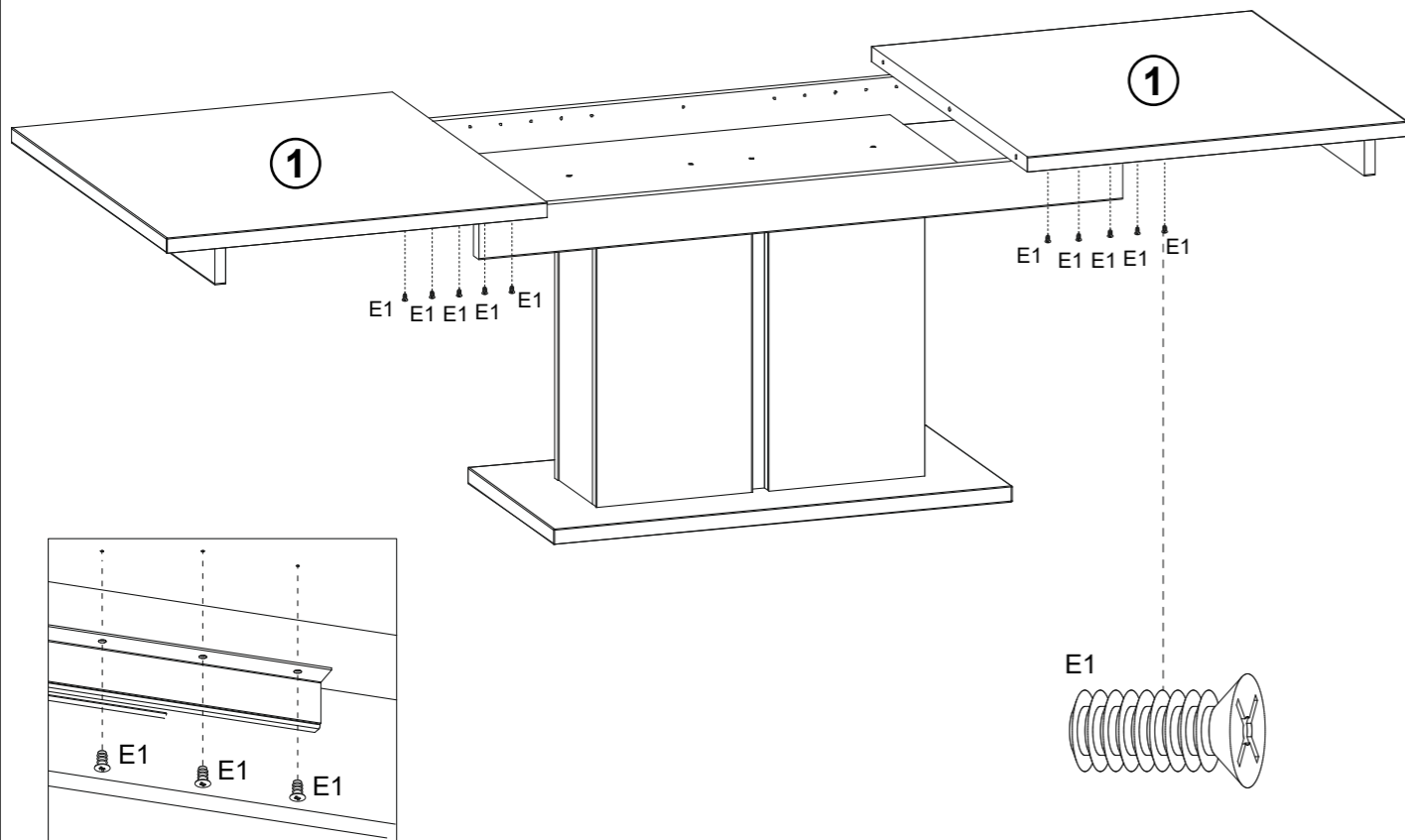

MODELL: CN16

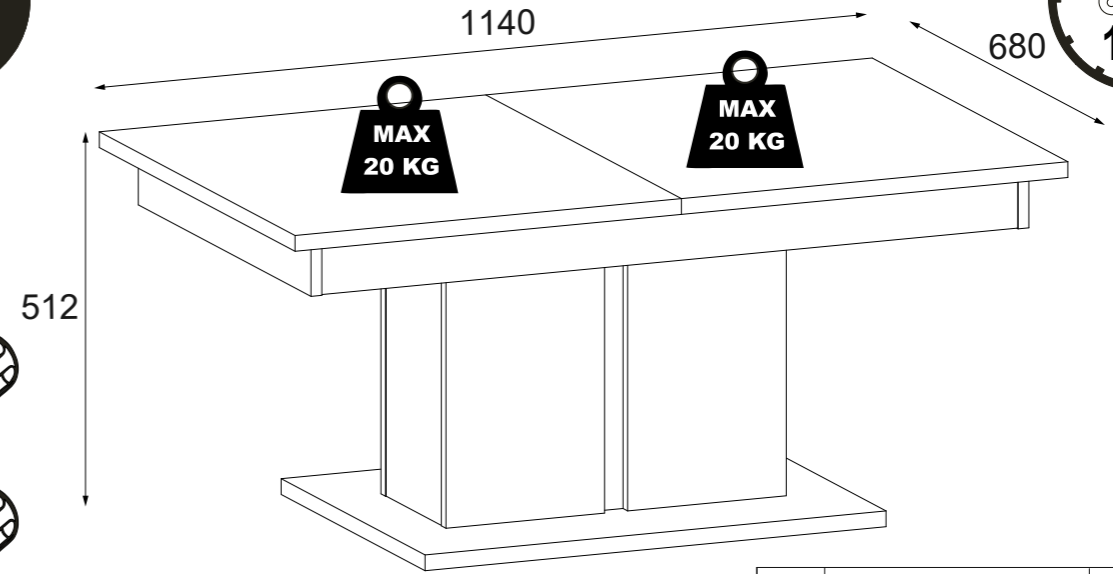
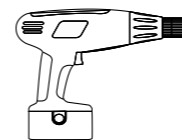
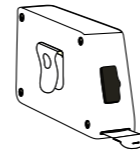
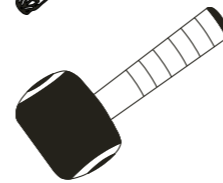
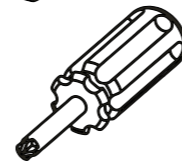
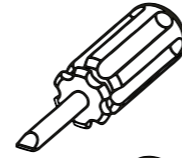

A	B (mm)		C	D
1	680	570	22	x2 1/1
2	680	300	22	x1 1/1
3	680	500	22	x1 1/1
4	1027	74	16	x2 1/1
5	600	75	16	x2 1/1
6	660	75	16	x1 1/1
7	390	234	16	x4 1/1
8	390	194	16	x2 1/1
9	390	100	16	x2 1/1

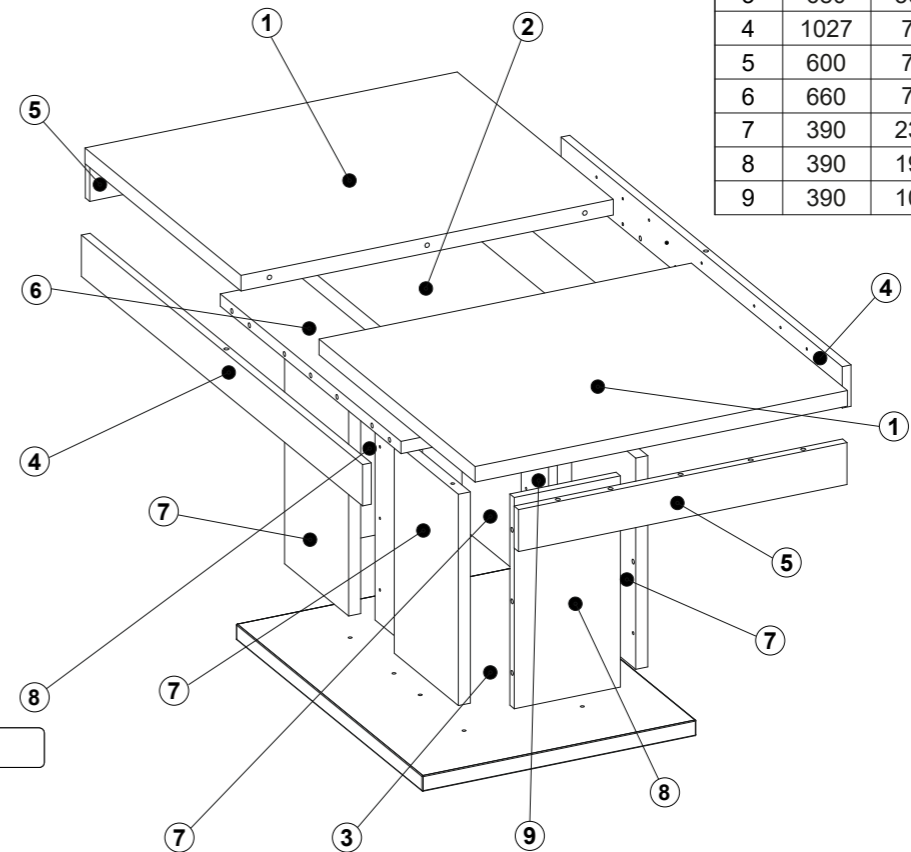

22x 45mm T1	22x Ø 15x12mm M1	14x Ø 20mm ZN1	8x Ø 12mm ZN2	16x Ø 6,3x50mm K5	16x Ø 8x30mm K1	4x Ø 15mm N1
34x Ø 5x11 mm E1	8x Ø 4,2x13mm WP2	12x Ø 4x30 mm WP9	6x Ø 8mm KU1	4x 50mm H1	1x 850mm PS1	1x 4mm K20

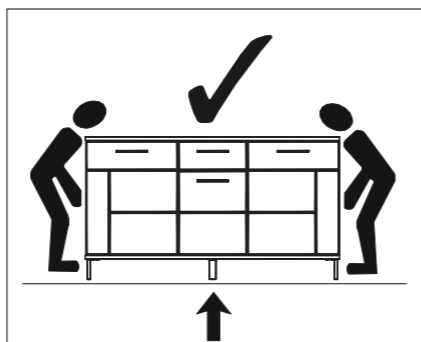
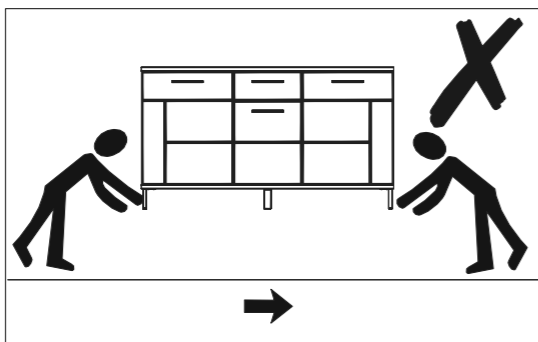
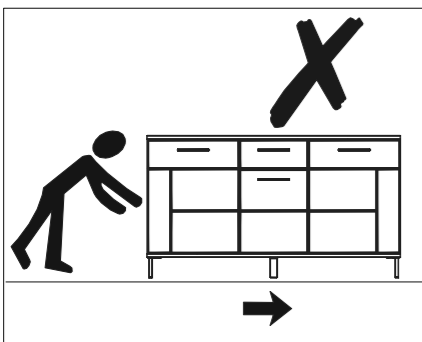
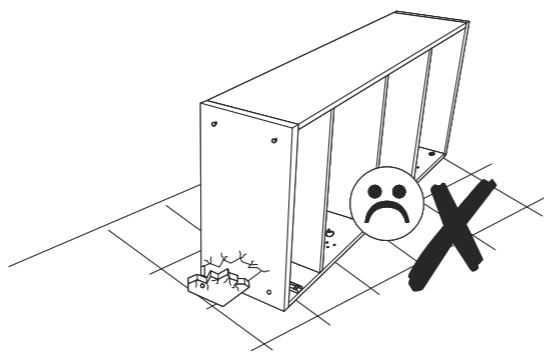
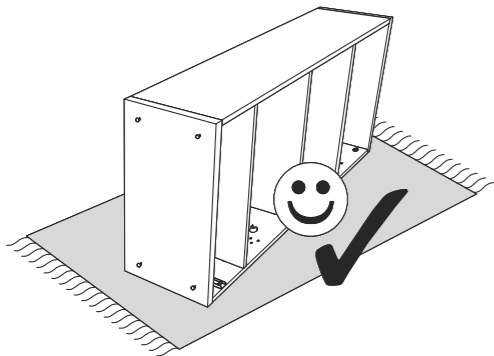
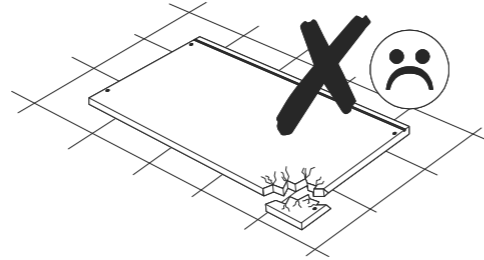
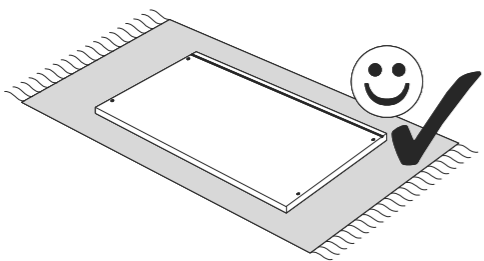
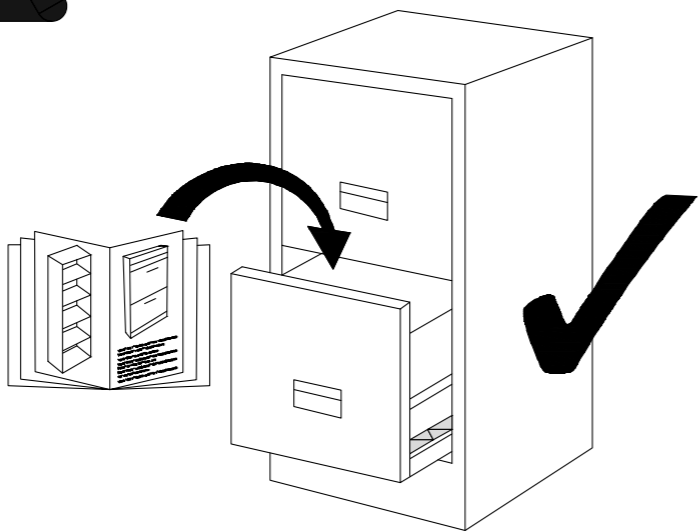
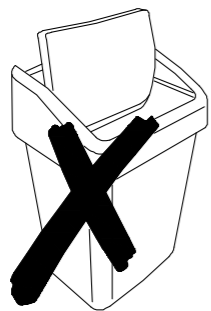

3

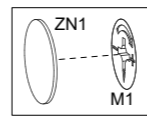
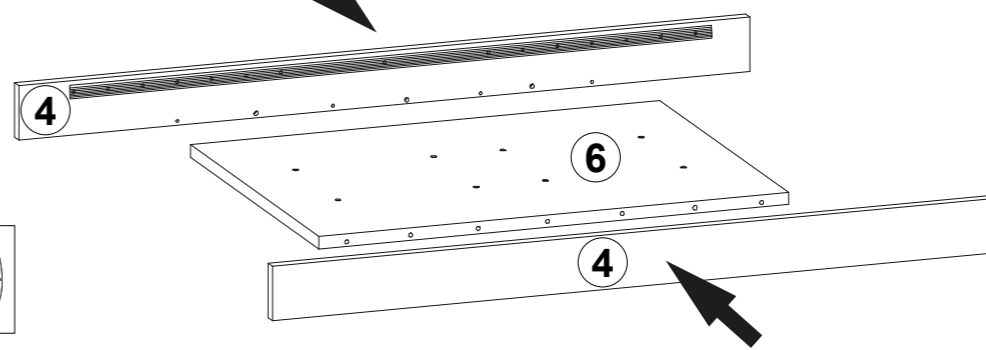
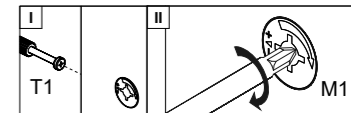

4

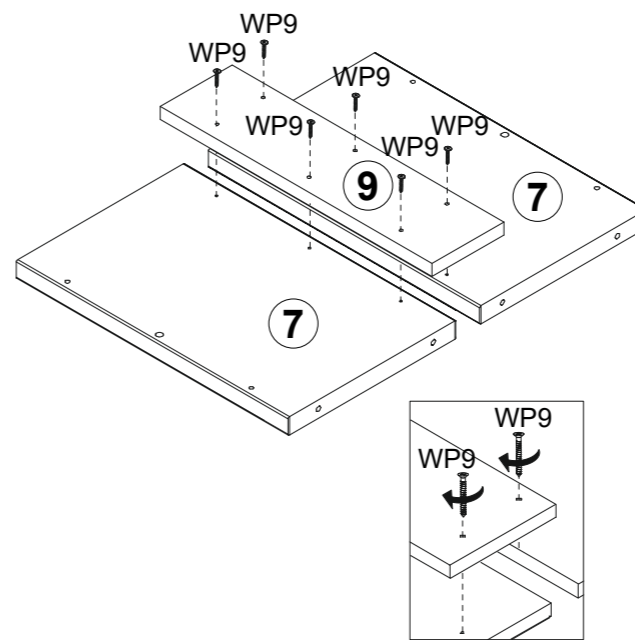

5

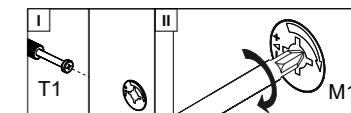
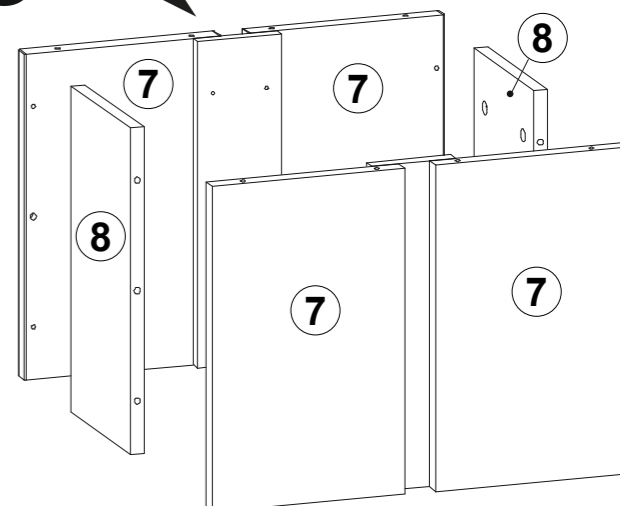

6

